

Microcontroller

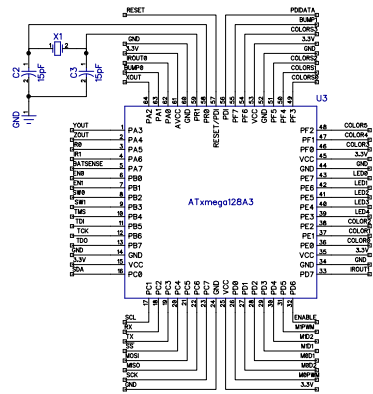

LED Indicators

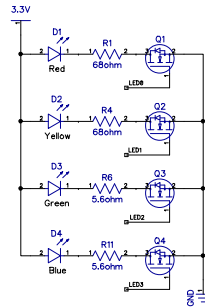

Accelerometer

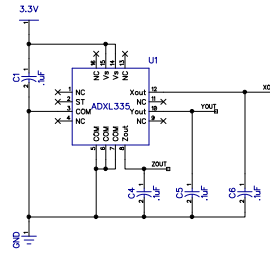

Battery Management

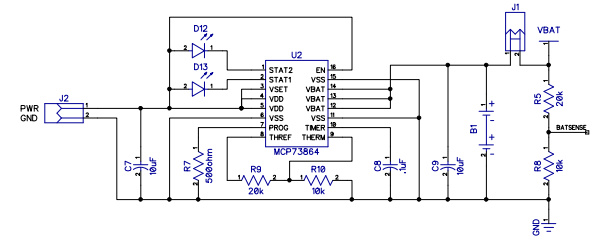

Decoupling Capacitors

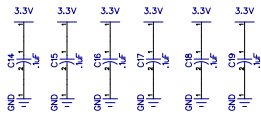

Bump Sensors

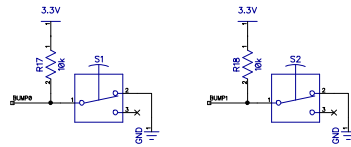

PDI Programming Port

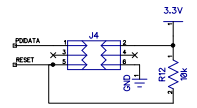

JTAG Programming Port

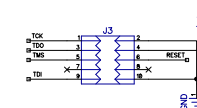

Power Regulation

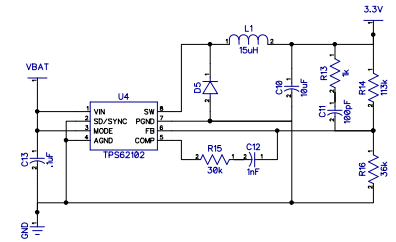

Reflective IR Sensors

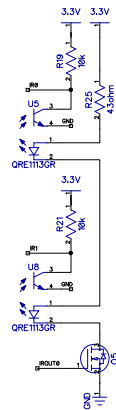

Encoder Sensors

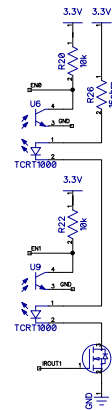

Motor Controller

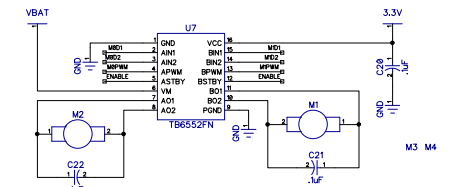

Expansion Ports

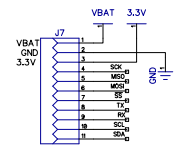

User Pushbuttons

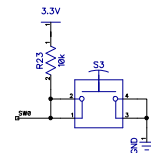

Reflective Color Sensors

